

**SBC8161**

**Socket 370 Full-size  
All-in-One  
CPU Card Series**

**User's Manual**

## **Disclaimers**

The information in this manual has been carefully checked and is believed to be accurate. AXIOM Technology Co., Ltd. assumes no responsibility for any infringements of patents or other rights of third parties which may result from its use.

AXIOM Technology assumes no responsibility for any inaccuracies that may be contained in this document. AXIOM Technology makes no commitment to update or to keep current the information contained in this manual.

AXIOM Technology reserves the right to make improvements to this document and/or product at any time and without notice.

No part of this document may be reproduced, stored in a retrieval system, or transmitted, in any form or by any means, electronic, mechanical, photocopying, recording, or otherwise, without the prior written permission of AXIOM Technology Co., Ltd.

**©Copyright 2001 by AXIOM Technology Co., Ltd.  
All rights reserved.  
November 2001, Version A6  
Printed in Taiwan**

## **ESD Precautions**

Integrated circuits on computer boards are sensitive to static electricity. To avoid damaging chips from electrostatic discharge, observe the following precautions:

- Do not remove boards or integrated circuits from their anti-static packaging until you are ready to install them.
- Before handling a board or integrated circuit, touch an unpainted portion of the system unit chassis for a few seconds. This helps to discharge any static electricity on your body.
- Wear a wrist-grounding strap, available from most electronic component stores, when handling boards and components.

## **Trademarks Acknowledgments**

AXIOM is a trademark of AXIOM Technology Co., Ltd.

IBM is a registered trademark of International Business Machines Corporation.

MS-DOS, and Windows 95/98/NT/2000 are trademarks of Microsoft Corporation.

Award is a trademark of Award Software, Inc.

IBM, PC/AT, PS/2, VGA are trademarks of International Business Machines Corporation.

Intel and Celeron, Pentium III are trademarks of Intel Corporation.

C&T is a trademark of Chips and Technologies, Inc.

Realtek is a registered trademark of Realtek Semiconductor Corporation.

Other brand names and trademarks are the properties and registered brands of their respective owners.

**This page does not contain any information.**

# Table of Contents

<b>Chapter 1 Introduction</b> .....	<b>1</b>
1.1 General Description .....	1
1.2 Specifications .....	2
1.3 Utilities Supported .....	3
1.4 Board Dimensions.....	4
<b>Chapter 2 Jumpers and Connectors</b> .....	<b>5</b>
2.1 Board Layout .....	5
2.2 Jumper Settings.....	6
2.2.1 Power Selection of Flat Panel Connector (VDDM of CN2): JP5.....	7
2.2.2 Power Supply Type Selection: JP7 .....	7
2.2.3 CMOS Clear Jumper: JP10.....	7
2.2.4 PS/2 Mouse Function Selection: JP11 .....	7
2.2.5 Watchdog Trigger Mode Setting: JP12 .....	8
2.2.6 DiskOnChip™ Memory Segment: JP14.....	8
2.2.7 COM2 RS232/422/485 Settings: JP17, JP18, JP19 .....	8
2.3 Connectors.....	9
<b>Chapter 3 Installation</b> .....	<b>11</b>
3.1 System Memory .....	11
3.2 CPU Installation.....	11
3.3 Ultra DMA/66 Drive Installation.....	12
3.4 Completing Installation.....	13
<b>Chapter 4 Hardware Description</b> .....	<b>15</b>
4.1 Microprocessors .....	15
4.2 BIOS.....	15
4.3 I/O Port Address Map.....	16
4.4 Interrupt Controller.....	17
4.5 General Output Connector.....	18
4.6 Enhanced IDE Interface Connector .....	19
4.7 VGA Interface.....	19
4.7.1 Flat Panel/CRT Interface Controller .....	19
4.7.2 Features .....	20
4.7.3 VGA/Flat Panel Connector: CN17, CN2, CN1 .....	20

4.7.4	Flat Panel Connector Pin Description .....	22
4.8	Ethernet Connector .....	22
4.9	SCSI Connector .....	22
4.10	Floppy Disk Controller .....	23
4.11	Parallel Port Interface .....	23
4.12	Serial Port Interface .....	23
4.12.1	Serial Ports IRQ Selection .....	23
4.13	Keyboard and PS/2 Mouse Connectors .....	24
4.14	USB Connector .....	25
4.15	IrDA Connector .....	25
4.16	ACPI Connector .....	26
<b>Chapter 5 Display Introduction -----</b>		<b>27</b>
5.1	Introduction .....	27
5.2	Features .....	27
5.3	Drivers Supported .....	28
<b>Chapter 6 Ethernet Introduction -----</b>		<b>29</b>
6.1	Introduction .....	29
6.2	Features .....	29
6.3	Drivers Supported .....	29
<b>Chapter 7 BIOS Configuration -----</b>		<b>31</b>
7.1	BIOS Introduction .....	31
7.2	BIOS Setup .....	31
7.3	Standard CMOS Setup .....	33
7.3	Standard CMOS Setup .....	33
7.4	BIOS Features Setup .....	36
7.4.1	Onboard VGA Functions .....	40
7.5	Chipset Features Setup .....	41
7.6	Power Management Setup .....	43
7.6.1	PM Timers .....	45
7.6.2	PM Events .....	46
7.7	PNP/PCI Configuration .....	47
7.8	Load BIOS Defaults .....	49
7.9	Load Setup Defaults .....	50
7.10	Integrated Peripherals .....	51

7.11	Supervisor / User Password .....	53
7.12	IDE HDD Auto Detection .....	54
7.13	Save & Exit Setup.....	55
7.14	Exit Without Saving.....	56
	<b>Appendix A Watchdog Timer .....</b>	<b>57</b>
	<b>Appendix B Connector Pin Assignments .....</b>	<b>59</b>
	<b>Appendix C Ultra DMA/66 Reference .....</b>	<b>65</b>

**This page does not contain any information.**



# Chapter 1

## Introduction

### 1.1 General Description

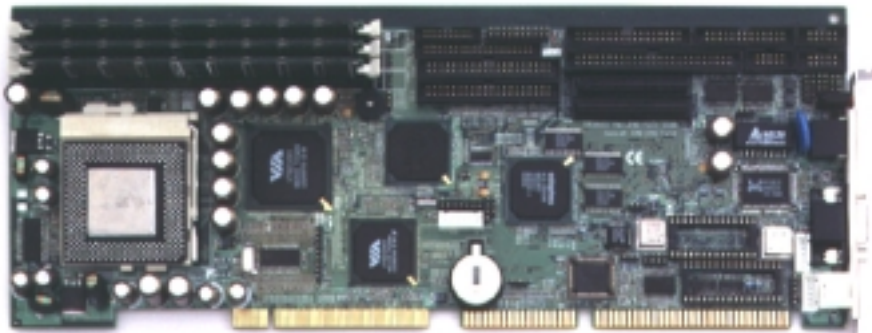

The **SBC8161 Series** CPU card is an industrial grade CPU card incorporating the VIA Apollo Pro VT82C693A/Super South VT82C686A chipset and the Chips & Technologies C&T69000 Flat panel VGA controller, both ensuring its compatibility with PCI bus passive backplanes. Its 6-layer structure reduces signal noise and built-in power management feature. These advanced concepts along with the PCI Local Bus architecture bring outstanding performance to Windows-based applications.

Designed for the professional embedded developers, the Socket 370 all-in-one **SBC8161 Series** CPU card is virtually your ultimate one-step solution to various applications.

## **1.2 Specifications**

- **Chipset:** VIA VT82C693A, VT82C686A with integrated real-time clock
- **CPU Socket:** Socket 370
- **Bus Clock:** 66/100/133 MHz
- **CPU:** Intel Socket 370 Celeron / Pentium III up to 1GHz
- **L2 Cache:** Integrated in CPU
- **BIOS:** Award 2MB PnP Flash BIOS
- **System Memory:**
  - 3x168 pin DIMM sockets. Support up to 1.5GB SDRAM
- **IDE Interface:** 2 bus mastering EIDE up to four devices, Ultra DMA/66 supported
- **FDD Interface:** Supports up to 2 drives
- **Serial Ports:** Two 16550 UARTs ports with 16 byte as one RS-232 and one RS-232/422/485
- **Parallel Ports:** One parallel port with ECP/EPP/SPP supported
- **VGA/Flat Panel Controller:**
  - AGP interface controller with integrated 2MB SDRAM
  - VGA chipset C&T 69000 AGP 1x supporting CRT/LCD displays
  - Supports up to 1280x1024 256-color resolution on non-interlaced CRT monitors, and 1024x768 16 bit-color on LCD panel monitors
- **Ethernet:**
  - Realtek 8139 PCI Bus 10/100M Base-T
  - Onboard Wake On LAN (via ATX power supply)
  - Onboard RJ-45 connector

- **Ultra2 Wide SCSI :**
  - Adaptec AIC-7890 PCI Bus Ultra2 Wide SCSI interface and Adaptec AIC-3860 Ultra Wide/Narrow SCSI interface
  - One 68-pin 16-bit differential Ultra2 Wide SCSI port, one 68-pin 16-bit Ultra Wide SCSI port and one 50-pin 8-bit Ultra SCSI port
  - Connects up to 15 SCSI peripherals with Ultra2 Wide SCSI feature
  - Provide data transfer rates up to 80 Mbytes/sec with Ultra2 Wide SCSI, 40 Mbytes/sec with Ultra Wide SCSI and 20 Mbytes/sec with Ultra SCSI interface
- **USB Interface:** two USB ports; USB Spec. Rev. 1.1 compliant
- **IrDA:** 1 IrDA pin-header for wireless communication
- **Hardware Monitoring:** Built-in VT86C686A, monitoring for CPU/System temperature, system voltage, and fan speed
- **Watchdog Timer:**
  - Generates a system reset
  - Software programmable time interval and jumper selectable
  - 64 levels, 0.5~8/5~80/50~800/100~1600 seconds
- **SSD:** Supports M-Systems DiskOnChip™ 2000 serials
- **Dimensions:** 122(W) x 335(L) mm

NOTE: *Specifications are subject to change without notice.*

### **1.3 Utilities Supported**

- VIA Chipset Drivers
- SCSI Utility and Drivers (SCSI functions only)
- Ethernet Utility and Drivers
- Flat panel/CRT Drivers
- System Doctor

## 1.4 Board Dimensions

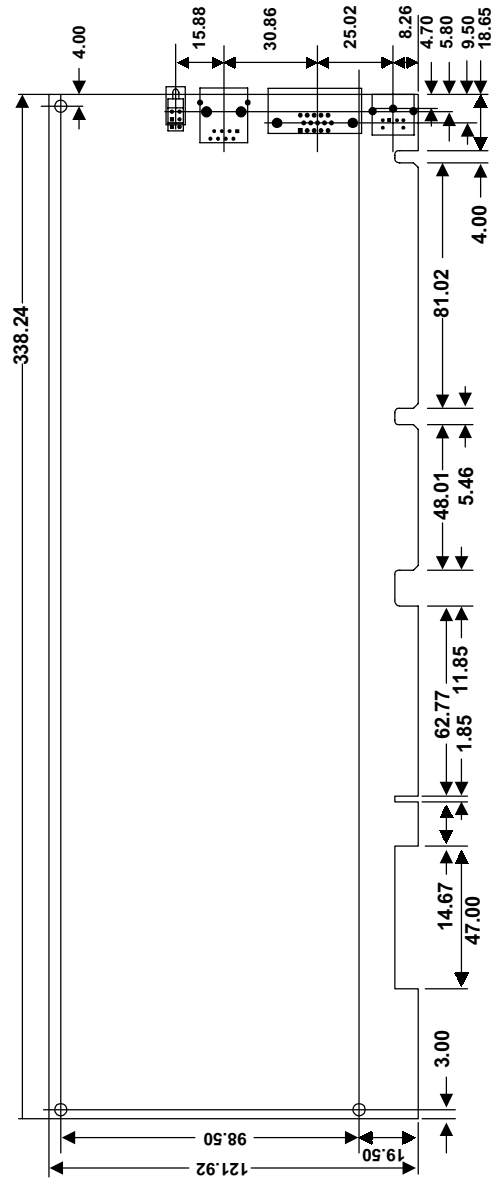

## Chapter 2 Jumpers and Connectors

### 2.1 Board Layout

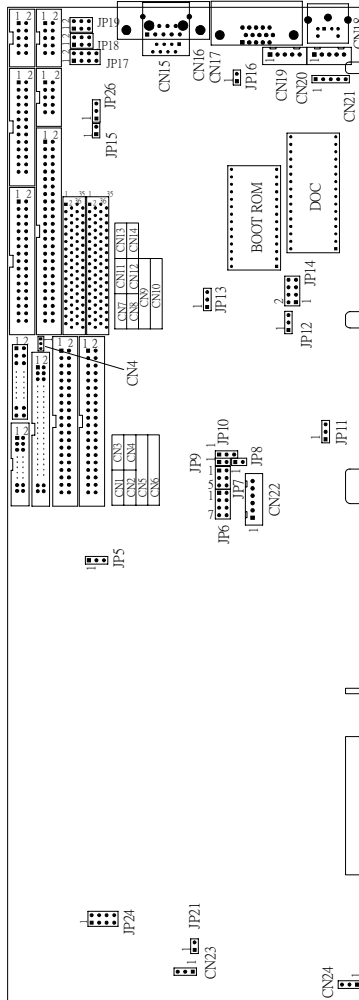

## 2.2 Jumper Settings

Making the proper jumper settings configures the **SBC8161 Series** to match the needs of your application. The following summary table lists all onboard jumpers and their corresponding functions and/or default settings.

Jumper	Default Function Setting	Default Jumper Setting
JP1	-----	-----
JP2	-----	-----
JP3	-----	-----
JP4	-----	-----
JP5	Power Selection 3.3V of Flat Panel Connector (VDDM of CN2)	Short 2-3
JP6	-----	-----
JP7	Power Supply Type For AT Power Supply Setting	Short 1-3, 2-4
JP8	-----	-----
JP9	-----	-----
JP10	CMOS Clear Jumper For Normal Mode	Short 1-2
JP11	PS/2 Mouse Function Enable Setting	Short 1-2
JP12	Watchdog Disable Mode Setting	Open
JP13	Reserved	Open
JP14	DiskOnChip Memory Segment For DC000-DFFFF Setting	Short 7-8
JP15	-----	-----
JP16	Reserved	Short
JP17	COM2 RS232 Settings	Short 1-2, 7-8
JP18	COM2 RS232 Settings	Short 3-5, 4-6
JP19	COM2 RS232 Settings	Short 3-5, 4-6
JP20	-----	-----
JP21	-----	-----
JP22	-----	-----
JP23	-----	-----

Continued . . . . .

Jumper	Function	Default
JP24	-----	-----
JP25	-----	-----
JP26	Reserved	Open

### 2.2.1 Power Selection of Flat Panel Connector (VDDM of CN2): JP5

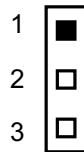

VDDM	Settings
5V	Short 1-2
3.3V (default)	Short 2-3

**SBC8161 Series** supports +3.3V or +5V flat panel displays. When using such type of flat panels, configure jumper **JP5** to the appropriate voltage of the flat panel.

### 2.2.2 Power Supply Type Selection: JP7

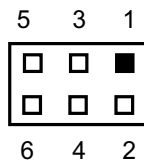

Options	Settings
AT P/S (default)	Short 1-3, 2-4
ATX P/S	Short 3-5, 4-6

### 2.2.3 CMOS Clear Jumper: JP10

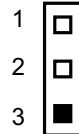

Options	Settings
Clear CMOS	Short 2-3
Normal (default)	Short 1-2

### 2.2.4 PS/2 Mouse Function Selection: JP11

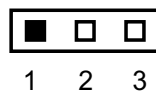

Options	Settings
Enabled (default)	Short 1-2
Disabled	Short 2-3

### 2.2.5 Watchdog Trigger Mode Setting: JP12

The watchdog timer is an indispensable feature of the **SBC8161 Series**. It has a sensitive error detection function and a report function. When the CPU processing comes to a halt, the watchdog either generates a NMI or resets the CPU.

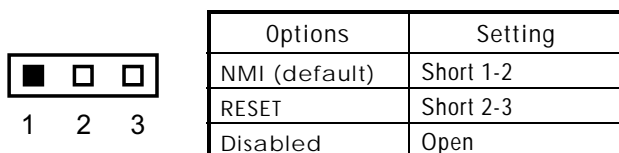

### 2.2.6 DiskOnChip™ Memory Segment: JP14

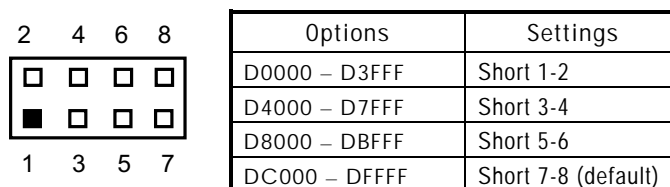

### 2.2.7 COM2 RS232/422/485 Settings: JP17, JP18, JP19

COM2	JP19	JP18	JP17
RS-232 (default)	Short 3-5, 4-6	Short 3-5, 4-6	Short 1-2
RS-422	Short 1-3, 2-4	Short 1-3, 2-4	Short 3-4
RS-485	Short 1-3, 2-4	Short 1-3, 2-4	Short 5-6, 7-8

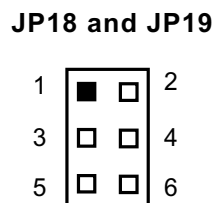
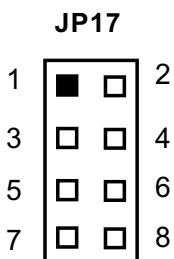



## 2.3 Connectors

The connectors allow the CPU card to connect with other parts of the system. Some problems encountered by your system may be a result from loose or improper connections. Ensure that all connectors are in place and firmly attached. The following table lists the function of each connector on the **SBC8161 Series**. Their corresponding pin assignments are described in Chapter 4 and Appendix B.

Connectors And Socket	Label
LCD-2 Connector	CN1
LCD Connector	CN2
General Output Connector	CN3
External LAN Card Wake On LAN Connector	CN4
Primary IDE Connector	CN5
Secondary IDE Connector	CN6
FDD Connector	CN7
50-pin Narrow SCSI Connector (Only by SBC8161VES)	CN8
68-pin Ultra Wide SCSI Connector (Only by SBC8161VES)	CN9
68-pin Ultra2 Wide SCSI Connector (Only by SBC8161VES)	CN10
Printer Port Connector	CN11
COM2	CN12
COM1 (Only by SBC8161VES and SBC8161VE)	CN13
USB Connector	CN14
Ethernet Connector (Only by SBC8161VES and SBC8161VE)	CN15
COM1 (Only by SBC8161V and SBC8161)	CN16
VGA Connector	CN17
Keyboard and Mouse Connector	CN18
PS/2 Mouse Connector	CN19
PS/2 Keyboard Connector	CN20

Continued . . . . .

Connectors And Socket	Label
IR Connector	CN21
ACPI Connector	CN22
Case Fan Connector	CN23
CPU Fan Connector	CN24
DiskOnChip® Socket	U15
Ethernet Boot ROM Socket	U12

## Chapter 3

### Installation

This chapter describes the hardware installation procedures on the **SBC8161 Series** all-in-one Socket 370 CPU card. The following is a list of typical peripherals required to build a minimum system:

- Power supply and passive backplane (optional)
- IBM™ PC/AT keyboard
- Display monitor
- Floppy or hard disk with MS-DOS or Flash Disk emulator

#### 3.1 System Memory

The **SBC8161 Series** industrial CPU card supports one 168-pin DIMM (Dual In-line Memory Module) socket for a maximum total memory up to 1.5GB SDRAM. The memory module can come in sizes of 16MB, 32MB, 64MB, 128MB, 256MB and 512MB SDRAMs.

NOTE: *Use SDRAM modules with PC100 or PC133 specification when running 100/133MHz CPU bus speed. With 66MHz CPU bus speed, SDRAM modules with PC66, PC100 or PC133 specification can be used. You have to install the Intel Celeron or Pentium III processor before installing the memory modules.*

#### 3.2 CPU Installation

1. Align pin one (e.g., white dot) of the CPU with pin one of the socket. Pin one of the CPU socket may either be marked on the board or indicated by an arrow head symbol on one corner of the socket. Normally, its diagonal corner distinguishes pin one on the socket.
2. To complete the CPU installation, gently press the CPU into place.
3. Double-check the insertion and orientation of the CPU before applying power. Improper installation will result

in permanent damage to the CPU.

### 3.3 Ultra DMA/66 Drive Installation

To accommodate the fast transfer rate of Ultra DMA/66, an 80-conductor cable (with 40 pin connectors on both ends) is necessary when installing Ultra DMA/66 drives. The **SBC8161 Series**, on this aspect, can support a total of 4 Ultra DMA/66 drives. It is through the Primary IDE Connector (**CN5**) and Secondary IDE Connector (**CN6**) where the cables are connected. The diagram below illustrates the proper installation procedure, including color coding of connectors, of the 80-conductor cable.

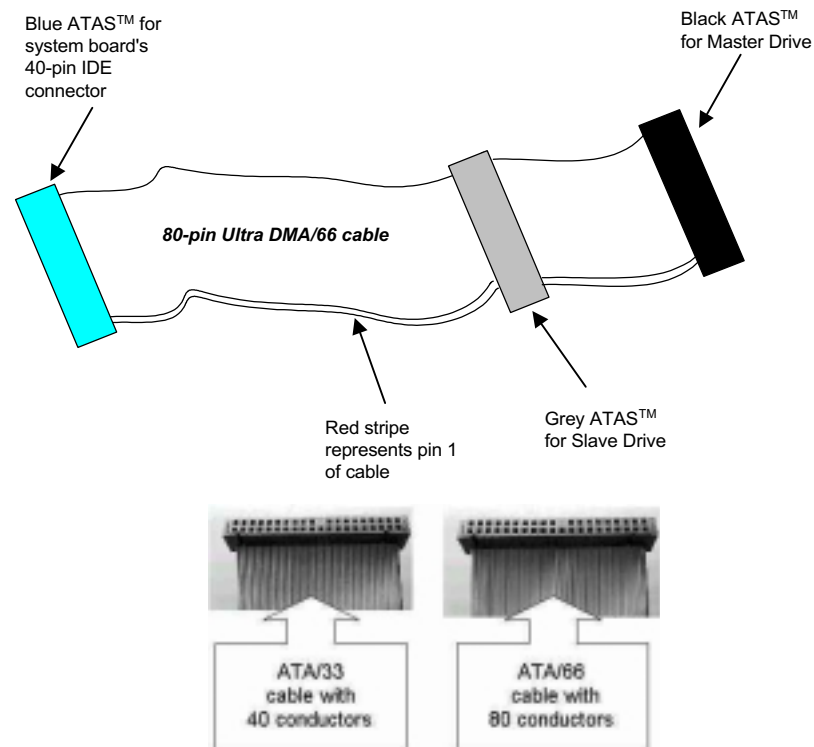

### **3.4 Completing Installation**

To complete the installation, follow the steps listed below.

1. Make sure the power is OFF.
2. Set the configuration jumpers according to the jumper settings on Chapter 2.
3. Install the **SBC8161 Series** CPU card into one of the slots on the passive backplane. You may allow the **SBC8161 Series** to stand alone as a single board computer.
4. Connect the I/O cables and peripherals, i.e. floppy disk, hard disk, monitor, keyboard, power supply and etc. to the CPU board.

NOTE: *The color of pin one is usually red or blue, while others are gray.*

5. Turn ON the system power.

**This page does not contain any information.**

## Chapter 4

### Hardware Description

This chapter gives a detailed explanation of the hardware features onboard the **SBC8161 Series** all-in-one Socket 370 CPU cards.

#### 4.1 Microprocessors

The **SBC8161 Series** supports Intel Celeron or Pentium III CPUs. Systems based on these CPUs can be operated under UNIX, OS/2, Linux, Windows NT/2000, Windows 95/98 and MS-DOS environments. The system's performance depends on the installed CPU on the board. When installing a new CPU, the jumpers including CPU type, CPU Clock, CPU Voltage and Bus Clock may need to be adjusted. Make sure all the settings are correct for the installed CPU to prevent any damage to the CPU.

#### 4.2 BIOS

The system BIOS used in **SBC8161 Series** is Award Plug and Play BIOS. The **SBC8161 Series** contains a single 2MB Flash EPROM. For more detailed information, refer to Chapter 7 for a complete description of the BIOS setup utility and the available features accompanying it.

### **4.3 I/O Port Address Map**

The CPU card communicates via I/O ports. It has a total of 1KB port addresses that can be assigned to other devices via I/O expansion cards.

Address	Devices
000-01F	DMA controller #1
020-03F	Interrupt controller #1
040-05F	Timer
060-06F	Keyboard controller
070-07F	Real time clock, NMI
080-09F	DMA page register
0A0-0BF	Interrupt controller #2
0F0	Clear math coprocessor busy signal
0C0-0DF	DMA controller #2
0F1	Reset math coprocessor
0F8-0FF	Math processor
120	Disable watchdog timer operation (read)
121	Enable watchdog timer operation (read)
122	Watchdog
1F0-1F8	Fixed disk controller
200-207	Game port
300-31F	Prototype card
360-36F	Reserved
378-37F	Parallel port #1
3B0-3BF	MDA video card (including LPT1)
3C0-3CF	EGA card
3D0-3DF	CGA card
3F0-3F7	Floppy disk controller
3F8-3FF	Serial port #1 (COM1)
2F8-2FF	Serial port #2 (COM2)



## 4.4 Interrupt Controller

The **SBC8161 Series** is a fully PC compatible control board. It consists of 16 ISA interrupt request lines and 4 of the 16 can be either ISA or PCI. The mapping list of the 16 interrupt request lines is shown below;

NMI	Parity check error
IRQ0	System timer output
IRQ1	Keyboard
IRQ2	Interrupt rerouting from IRQ8 through IRQ15
IRQ3	Serial port #2
IRQ4	Serial port #1
IRQ5	Reserved
IRQ6	Floppy disk controller
IRQ7	Parallel port #1
IRQ8	Real time clock
IRQ9	Reserved
IRQ10	Reserved
IRQ11	USB/VGA
IRQ12	PS/2 Mouse
IRQ13	Math coprocessor
IRQ14	Primary IDE channel
IRQ15	Secondary IDE Channel

## 4.5 General Output Connector

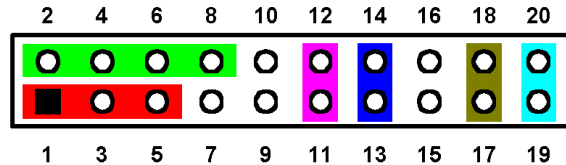

### Power LED

This 3-pin connector, designated at **Pins 1, 3, and 5 of CN3**, connects the system power LED indicator to its respective switch on the case. **Pins 1 & 3** are +, and **pin 5** is assigned as -. The Power LED lights up when the system is powered ON and blinks when it is in Sleep mode.

### External Speaker and Internal Buzzer Connector

**Pins 2, 4, 6, and 8 of CN3** connect to the case-mounted speaker unit or internal buzzer. **Short pins 4-6** when connecting the CPU card to an internal buzzer. When connecting an external speaker, set these jumpers to **Open** and install the speaker cable on pin 8 (+).

### External SMI Button Switch

This switch enables the connection between the **SBC8161-**based system and the installed hardware. **Pins 11 & 12 of CN3** support the SMI switch function.

### System Reset Switch

**Pins 17 & 18 of CN3** connect to the case-mounted reset switch and allow rebooting of your computer instead of turning OFF the power switch. This is a preferred method of rebooting in order to prolong the life of the system's power supply.

### HDD Activity LED

This connector extends to the hard drive activity LED on the control panel. This LED will flash when the HDD is being accessed. **Pins 19 & 20 of CN3** connect the hard disk drive and the front panel HDD LED. **Pins 19** is -, and **pin 20** is assigned as +.

#### ATX Power On/Off Button

This 2-pin connector, designated at **Pins 13 & 14** of **CN3**, connects the ATX power button of the front panel to the **SBC8161 Series** CPU card – allowing user to control the power on/off state of the ATX power supply. This jumper is only useful when installing an ATX power supply and **CN22** cable to the system.

#### Reserved pins

**Pins 7, 9, 10, 15, and 16** of **CN3** are reserved pins.

## 4.6 Enhanced IDE Interface Connector

The **SBC8161 Series** includes a PCI bus enhanced IDE controller that can support master/slave mode and post write transaction mechanisms with 64-byte buffer, and master data transaction. This feature, connected via connector **CN5** and **CN6**, allows the **SBC8161 Series** to handle 4 IDE drives. Refer to Appendix B for the pinout assignments of **CN5** and **CN6**.

## 4.7 VGA Interface

### 4.7.1 Flat Panel/CRT Interface Controller

The built-in C&T 69000 is a high-performance flat panel/super VGA display controller with onboard 2M bytes VGA RAM. It is capable of driving a wide array of flat panel and CRT displays. It can also support CRT at a maximum resolution of up to 1280x1024 with 256 colors, 640x480 with 16M colors, and panel resolutions of 1024x768. The C&T 69000 also supports monochrome panels up to 64 gray scales. It displays up to 226,981 different colors on passive STN flat panels and up to 16M colors on 24-bit active matrix flat panels.

### 4.7.2 Features

- Fully compatible with IBM™ VGA
- Flat panel and CRT monitor can be displayed simultaneously
- Onboard 2M bytes VGA RAM
- Supports panel resolution up to 1024x768
- Supports non-interlaced CRT monitors with resolutions up to 1280x1024 256 colors
- Direct interface to Color and Monochrome Dual Drive and Single Drive panels
- SMARTMAP™ intelligent color to gray scale conversion enhances text legibility
- Integrated programmable linear address feature accelerates GUI performance
- Hardware Windows acceleration
- Built-in 44 pins general purpose connector for flat panel display, and an extended 20-pin for 36 bit XVGA flat panel

### 4.7.3 VGA/Flat Panel Connector: CN17, CN2, CN1

The **SBC8161 Series** has three connectors that support CRT VGA and flat panel displays, individually or simultaneously. **CN17** is a standard 15-pin pin header connector commonly used for the CRT VGA display, and **CN2** (44-pin) **CN1** (20-pin) are dual-in-line headers for flat panel connection. Configuration of the VGA interface is done via the software utility and no jumper setting is required. The following two tables are the pin assignments for the CRT/VGA connector and the flat panel connector.

#### CN17: CRT/VGA Connector Pin Assignment

Pin	Description	Pin	Description	Pin	Description
1	Red	2	Green	3	Blue
4	N/A	5	GND	6	AGND
7	AGND	8	AGND	9	N/A
10	GND	11	N/A	12	DDC DAT
13	Horizontal Sync	14	Vertical Sync	15	DDC CLK

**CN2: Flat Panel Connector Pin Assignment**

Pin	Description	Pin	Description	Pin	Description
1	-12V	2	+12VM	3	GND
4	GND	5	VDDM	6	VDDM
7	ENAVEE	8	GND	9	P0
10	P1	11	P2	12	P3
13	P4	14	P5	15	P6
16	P7	17	P8	18	P9
19	P10	20	P11	21	P12
22	P13	23	P14	24	P15
25	P16	26	P17	27	P18
28	P19	29	P20	30	P21
31	P22	32	P23	33	GND
34	GND	35	SHFCLK	36	FLM
37	M	38	LP	39	GND
40	ENABKL	41	GND	42	-SHFCLK
43	VDDM	44	VDDM		

**CN1: Flat Panel Connector for XGA**

Pin	Description	Pin	Description	Pin	Description
1	GND	2	GND	3	P24
4	P25	5	P26	6	P27
7	P28	8	P29	9	GND
10	GND	11	P30	12	P31
13	P32	14	P33	15	P34
16	P35	17	VDDM	18	VDDM
19	+12VM	20	+12VM		

#### 4.7.4 Flat Panel Connector Pin Description

Name	Description
P0~P35	Flat panel data output
ENABKL	Activity Indicator and Enable Backlight outputs
SHFCLK	Shift clock. Pixel clock for flat panel data
M	M signal for panel AC drive control
LP	Latch pulse. Flat panel equivalent of HSYNC
FLM	First line marker. Flat panel equivalent of VSYNC
+12VM	+12V power controlled by chipset
ENAVEE / ENAVDD	Power sequencing controls for panel LCD bias volt
VDDM	3.3V or 5V selected by JP9

#### 4.8 Ethernet Connector

The RJ-45 connector is used for Ethernet. To connect the **SBC8161 Series** to 10-Base-T or 100-Base-T hub, just plug one end of the cable into the **CN15** and connect the other end (phone jack) of the cable to a 10-Base-T hub.

#### 4.9 SCSI Connector

The **SBC8161 Series** provides three SCSI connectors for 80Mbps, 40Mbps and 20Mbps SCSI devices. This feature is not available on **SBC8161 Series** board.

- **CN10**: Ultra2 SCSI Connector, 68-pin supports 80Mbps SCSI devices
- **CN9**: Ultra Wide SCSI Connector, 68-pin supports 40Mbps SCSI devices
- **CN8**: Narrow SCSI Connector, 50-pin supports 20Mbps SCSI devices

## 4.10 Floppy Disk Controller

The **SBC8161 Series** provides a 34-pin header type connector, **CN7**, supporting up to two floppy drives. The floppy drives may be any one of the following types: 5.25" 360KB/1.2MB and 3.5" 720KB/1.44MB/2.88MB. The **CN7** pin assignment is listed in Appendix B.

## 4.11 Parallel Port Interface

The **SBC8161 Series** onboard **CN11** is a multi-mode parallel port able to support:

- **Standard mode:** IBM PC/XT, PC/AT and PS/2™ compatible with bi-directional parallel port
- **Enhanced mode:** Enhance parallel port (EPP) compatible with EPP 1.7 and EPP 1.9 (IEEE 1284 compliant)
- **High speed mode:** Microsoft and Hewlett Packard extended capabilities port (ECP) IEEE 1284 compliant

The address select of the onboard parallel port in LPT1 (3BCH) or disabled is done by BIOS CMOS setup.

## 4.12 Serial Port Interface

The serial interface onboard **SBC8161 Series** consists of COM1 port (**CN13**) supports RS-232 and COM2 (**CN12**) provide RS-232/422/485 connectivity.

### 4.12.1 Serial Ports IRQ Selection

**SBC8161 Series** uses a 10-pin connector for COM2 (**CN12**) and a DB9-pin connector for COM1 (**CN13**). Interrupt Requests on COM1 and COM2 are selected via IRQ4 and IRQ3 respectively. Additionally, both ports can be enabled or disabled via BIOS setting. The RS-232 pin assignments for COM1 and COM2 along with the RS-485 pin assignments for COM2 are in Appendix B.

### 4.13 Keyboard and PS/2 Mouse Connectors

The **SBC8161 Series** provides a keyboard (**CN20**) and PS/2 mouse (**CN19**) interface with a 5-pin connector. **CN18** is a DIN connector for PS/2 keyboard connection.

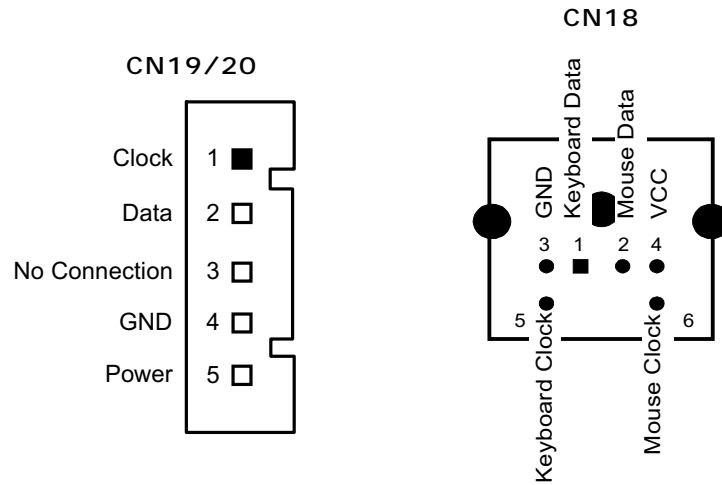



## 4.14 USB Connector

The Universal Serial Bus (USB) connector on the **SBC8161 Series** is for installation of peripherals supporting the USB interface. **CN14** is the 10-pin USB connector on the **SBC8161 Series**.

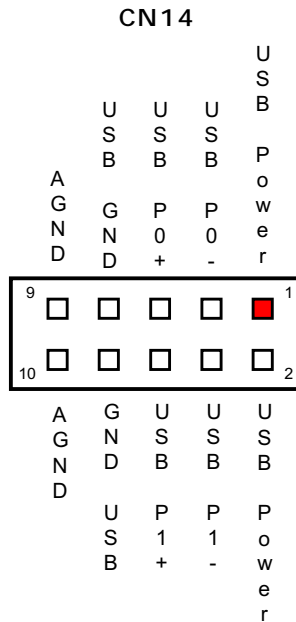

## 4.15 IrDA Connector

**CN21** is a 10-pin IrDA connector for wireless communication.

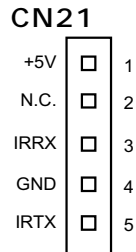

## 4.16 ACPI Connector

Advanced Configuration and Power Interface (ACPI) defines a flexible and extensible interface that allows system designers to select appropriate cost/feature trade-offs for power management. The interface enables and supports reliable power management through improved hardware and operating system coordination. The specification enables new power management technology to evolve independently in operating systems and hardware while ensuring that they continue to work together.

**CN22** on the **SBC8161 Series** is a 6-pin header connector that provides ACPI interface.

CN22

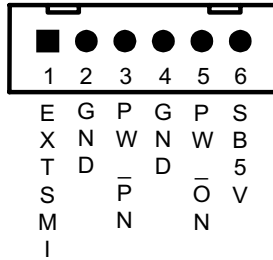

## **Chapter 5**

### **Display Introduction**

#### **5.1 Introduction**

The LCD/VGA chipset used on the **SBC8161 Series** that can drive a wide range of monochrome and color flat panels including Single-Drive (SS) and Dual-Panel, Dual Drive (DD) passive STN and active matrix TFT / MIM LCD, EL, and Plasma panels. The 69000 supports an additional 256Kx16 DRAM providing a 32-bit video memory bus. The 69000 accelerator can support up to 64 gray scales on monochrome panels, up to 226,981 colors on passive STN LCDs, and up to 16M colors on 24-bit active matrix LCDs. It also offers a variety of programmable features to optimize display quality, including tall font stretching, fast vertical centering and programmable vertical stretching in graphics for handling modes with less than 480 lines.

#### **5.2 Features**

- AGP interface controller with integrated 2MB SDRAM
- VGA chipset C&T 69000 AGP 1x supporting CRT/LCD displays
- Display memory supports up to 1280x1024 256-color resolution on non-interlaced CRT monitors, and 1024x768 16 bit-color on LCD panel monitors

### **5.3 Drivers Supported**

The 69000 is fully compatible with the VGA graphics standard at the register, gate, and BIOS levels. The manufacturer supplies fully VGA-compatible BIOS, end-user utilities and drivers for common application programs (e.g., Microsoft Windows™). CHIPS' drivers for Windows include a Big Cursor setting and fast panning / scrolling capabilities.

Make sure you know the version of the application for which you are installing drivers. Your *Display Driver Diskettes* contain drivers for several versions of certain applications. For your driver to operate properly, you must install the driver for your version of the application program.

NOTE: *Before you begin the driver software installation, please see the detail of installation procedure from the driver utility in CD-ROM and be sure to make backup copies of the Display Driver Diskettes.*

## Chapter 6

# Ethernet Introduction

### 6.1 Introduction

The **SBC8161 Series** is equipped with a high performance Plug and Play Ethernet interface which is fully compliant with the IEEE 802.3 standard, and consisting of a RJ-45 connector (CN25).

### 6.2 Features

- 10MB/s and 100MB/s operations
- Supports 10MB/s and 100MB/s N-Way auto negotiation
- Full duplex capability
- Full compliance with PCI Revision 2.1
- PCI Bus Master data transfers

### 6.3 Drivers Supported

Bundled with popular software drivers, the **SBC8161 Series** Ethernet interface allows great flexibility to work with all major networking operating systems including Novell NetWare v2.x, v3.x, v4.x, Microsoft LAN Manager, Win3.1, Win NT, Win95, IBM LAN Server, SCO UNIX or other ODI, NDIS and Packet drive compliant operating systems.

NOTE: *Before you begin the driver software installation, please see the detail of installation procedure from the driver utility in CD-ROM and be sure to make backup copies of the Display Driver Diskettes.*

**This page does not contain any information.**

## **Chapter 7**

### **BIOS Configuration**

Chapter 4 describes the different settings available in the Award BIOS that comes with the **SBC8161 Series** CPU card. Also contained here are instructions on how to set up the BIOS configuration.

#### **7.1 BIOS Introduction**

The Award BIOS (Basic Input/Output System) installed in your computer system's ROM supports Intel Celeron processors in a standard IBM-AT compatible I/O system. The BIOS provides critical low-level support for standard devices such as disk drives, serial and parallel ports. It also adds virus and password protection as well as special support for detailed fine-tuning of the chipset controlling the entire system.

#### **7.2 BIOS Setup**

The Award BIOS provides a Setup utility program for specifying the system configurations and settings. The BIOS ROM of the system stores the Setup utility. When you turn ON the computer, the Award BIOS is immediately activated. Pressing the <Del> key immediately allows you to enter the Setup utility. If you are a little bit late pressing the <Del> key, POST (Power On Self Test) will continue with its test routines, thus preventing you from invoking the Setup. If you still wish to enter Setup, restart the system by pressing the "Reset" button or simultaneously pressing the <Ctrl>, <Alt> and <Delete> keys. You can also restart by turning the system OFF and back ON again. The following message will appear on the screen:

**Press <DEL> to Enter Setup**

In general, you press the arrow keys to highlight items, <Enter> to select, the <PgUp> and <PgDn> keys to change entries, <F1> for help and <Esc> to quit.

When you enter the Setup utility, the Main Menu screen will appear on the screen. The Main Menu allows you to select from various setup functions and exit choices.

**ROM PCI/ISA BIOS  
CMOS SETUP UTILITY  
AWARD SOFTWARE, INC.**

STANDARD CMOS SETUP	INTEGRATED PERIPHERALS
BIOS FEATURES SETUP	SUPERVISOR PASSWORD
CHIPSET FEATURES SETUP	USER PASSWORD
POWER MANAGEMENT SETUP	IDE HDD AUTO DETECTION
PNP/PCI CONFIGURATION	SAVE & EXIT SETUP
LOAD BIOS DEFAULTS	EXIT WITHOUT SAVING
LOAD SETUP DEFAULTS	
Esc : Quit	↑ ↓ → ← : Select Item
F10 : Save & Exit Setup	(Shift) F2 : Change Color

The section below the setup items of the Main Menu displays the control keys for this menu. Another section located at the bottom of the Main Menu, just below the control keys section, displays information on the currently highlighted item in the list.

NOTE: *If you find that your computer cannot boot after making and saving system changes with Setup, the Award BIOS, via its built-in override feature, resets your system to the CMOS default settings.*

We strongly recommend that you avoid making any changes to the chipset defaults. These defaults have been carefully chosen by both Award and your system manufacturer to provide the absolute maximum performance and reliability.



### 7.3 Standard CMOS Setup

“Standard CMOS Setup” allows you to record some basic hardware configurations in your computer system and set the system clock and error handling. If the motherboard is already installed in a working system, you will not need to select this option. You will need to run the Standard CMOS option, however, if you change your system hardware configurations, the onboard battery fails, or the configuration stored in the CMOS memory was lost or damaged.

**ROM PCI/ISA BIOS  
STANDARD CMOS SETUP  
AWARD SOFTWARE, INC.**

Date (mm:dd:yy) : Wed, Mar 4 1998		Time (hh:mm:ss) : 00 : 00 : 00					
	CYLS	HEADS	PRECOMP	LANDZONE	SECTORS	MODE	
Primary Master :	AUTO ( 0Mb)	0	0	0	0	0	AUTO
Primary Slave :	AUTO ( 0Mb)	0	0	0	0	0	AUTO
Secondary Master :	AUTO ( 0Mb)	0	0	0	0	0	AUTO
Secondary Slave :	AUTO ( 0Mb)	0	0	0	0	0	AUTO
Drive A :	1.44M,3.5 in						
Drive B :	None						
Video :	EGA / VGA					Base Memory : 640K	
Halt On :	All Errors					Extended Memory : 15360K	
						Other Memory : 384K	
						Total Memory : 16384K	
ESC : Quit		↑ ↓ → ← : Select Item			PU / PD / + / - : Modify		
F1 : Help		(Shift) F2 : Change Color					

At the bottom of the menu are the control keys for use on this menu. If you need any help in each item field, you can press the <F1> key. It will display the relevant information to help you. The memory display at the lower right-hand side of the menu is read-only. It will adjust automatically according to the memory changed. The following pages describe each item of this menu.

- **Date**

The date format is:

Day	the day of week, from Sun to Sat, determined by the BIOS, is read only
Month	the month, Jan (1) through Dec (12)
Date	the date, from 1 to 31 (or the maximum allowed in the month), can key in the numerical / function key
Year	the year, from 1994 to 2079

To set the date, highlight the “Date” field and use the PageUp/PageDown or +/- keys to set the current time.

- **Time**

The time format is:

Hour	From 00 to 23
Minute	From 00 to 59
Second	From 00 to 59

To set the time, highlight the “Time” field and use the <PgUp>/<PgDn> or +/- keys to set the current time.

- **Primary HDDs / Secondary HDDs**

The onboard PCI IDE connectors provide Primary and Secondary channels for connecting up to four IDE hard disks or other IDE devices. Each channel can support up to two hard disks; the first is the “Master” and the second is the “Slave”.

To enter the specifications for a hard disk drive, you must select first a “Type”. There are 45 predefined types and 4 user definable types are for Enhanced IDE BIOS. Types 1 to 45 are predefined. Type “User” is user-definable. For the Primary Master/Slave as well as Secondary Master/Slave, you can select “Auto” under the TYPE and MODE fields. This will enable auto detection of your IDE drives and CD-ROM drive during POST.

Press <PgUp>/<PgDn> to select a numbered hard disk type or type the number and press the <Enter> key. The hard disk will not work properly if you enter incorrect information for this field. If your hard disk drive type is not matched or listed, you can use Type User to define your own drive type manually. If you select Type User, the utility will ask you to enter the information on the following table.

CYLS	number of cylinders
HEAD	number of read/write heads
PRECOMP	write precompensation
LANDZ	landing zone
SECTOR	number of sectors
SIZE	Automatically adjust according to the configuration
MODE (for IDE HDD only):	Auto Normal (HD < 528MB) Large (for MS-DOS only) LBA (HD > 528MB and supports Logical Block Addressing)

NOTE: *The specifications of your drive must match with the drive table. The hard disk will not work properly if you enter incorrect information in these fields. If your hard disk drive type is not matched or listed, you can use Type User to define your own drive type manually.*

- **Drive A / Drive B**

These fields identify the types of floppy disk drive A or drive B that has been installed in the computer. The available specifications are:

360K, 5.25 in	5.25 inch PC-type standard drive; 360Kb capacity
1.2M, 5.25 in	5.25 inch AT-type high-density drive; 1.2MB capacity
720K, 3.5 in	3.5 inch double-sided drive; 720Kb capacity
1.44M, 3.5 in	3.5 inch double-sided drive; 1.44MB capacity
2.88M, 3.5 in	3.5 inch double-sided drive; 2.88MB capacity

- **Video**

This field selects the type of video display card installed in your system. You can choose the following video display cards:

EGA/VG A	Enhanced Graphics Adapter/Video Graphics Array. For EGA, VGA, SEGA, SVGA or PGA monitor adapters. (default)
CGA 40	Color Graphics Adapter, power up in 40 column mode
CGA 80	Color Graphics Adapter, power up in 80 column mode
MONO	For Hercules or MDS adapters, includes high resolution monochrome adapters

● **Halt On**

This field determines whether the system will halt if an error is detected during power up.

No errors	The system boot will halt on any error detected. (default)
All errors	Whenever the BIOS detects a non-fatal error, the system will stop and you will be prompted.
All, But Keyboard	The system boot will not stop for a keyboard error; it will stop for all other errors.
All, But Diskette	The system boot will not stop for a disk error; it will stop for all other errors.
All, But Disk/Key	The system boot will not stop for a keyboard or disk error; it will stop for all other errors.

## 7.4 BIOS Features Setup

This section allows you to configure and improve your system and allows you to set up some system features according to your preference.

**ROM / PCI ISA BIOS  
BIOS FEATURES SETUP  
AWARD SOFTWARE, INC.**

Virus Warning	: Disabled	Video BIOS Shadow	: Enabled
CPU Internal Cache	: Enabled	C8000-CBFFF Shadow	: Disabled
External Cache	: Enabled	CC000-CFFFF Shadow	: Disabled
CPU L2 Cache ECC Checking	: Enabled	D0000-D3FFF Shadow	: Disabled
Quick Power On Self Test	: Disabled	D4000-D7FFF Shadow	: Disabled
Boot Sequence	: C,A,SCSI	D8000-DBFFF Shadow	: Disabled
Swap Floppy Drive	: Disabled	DC000-DFFF Shadow	: Disabled
Boot Up Floppy Seek	: Disabled		
Boot Up NumLock Status	: On		
IDE HDD Block Mode	: Enabled	LCD Type : (Type 6) 640x480 24 TFT	
Gate A20 Option	: Fast	VGA Expansion(Full Screen)	: Disable
Memory Parity/ECC Check	: Disabled	Display Type During POST	: CRT Only
Typematic Rate Setting	: Disabled	Display Type After POST	: CRT Only
Typematic Rate (Chars/Sec)	: 6		
Typematic Delay (Msec)	: 250	ESC : Quit	↑ ↓ → ← : Select Item
Security Option	: Setup	F1 : Help	PU/PD/+/- : Modify
PCI /VGA Palette Snoop	: Disabled	F5 : Old Values	(Shift) F2 : Color
OS Select For DRAM>64MB	: Non-OS2	F6 : Load BIOS Defaults	
		F7 : Load Setup Defaults	

- **Virus Warning**

This item protects the boot sector and partition table of your hard disk against accidental modifications. If an attempt is made, the BIOS will halt the system and display a warning message. If this occurs, you can either allow the operation to continue or run an anti-virus program to locate and remove the problem.

NOTE: *Many disk diagnostic programs, which attempt to access the boot sector table, can cause the virus warning. If you will run such a program, disable the Virus Warning feature.*
- **CPU Internal Cache / External Cache**

Cache memory is additional memory that is much faster than conventional DRAM (system memory). CPUs from 486-type on up contain internal cache memory, and most, but not all, modern PCs have additional (external) cache memory. When the CPU requests data, the system transfers the requested data from the main DRAM into cache memory, for even faster access by the CPU. These items allow you to enable (speed up memory access) or disable the cache function. By default, these are **Enabled**.
- **CPU L2 Cache ECC Checking**

When enabled, this allows ECC checking of the CPU's L2 cache. By default, this field is **Enabled**.
- **Quick Power On Self Test**

When enabled, this field speeds up the Power On Self Test (POST) after the system is turned ON. If it is set to **Enabled**, BIOS will skip some items.
- **Boot Sequence**

This field determines the drive that the system searches first for an operating system. The available options are:

  - A, C, SCSI
  - C, A, SCSI
  - C, CDROM, A
  - CDROM, C, A
  - D, A, SCSI
  - SCSI, C, A
  - C only
  - LS/ZIP, C
  - SCSI, A, C

The default value is **A, C, SCSI**.

- **Swap Floppy Drive**  
This allows you to determine whether to enable Swap Floppy Drive or not. When enabled, the BIOS swaps floppy drive assignments so that Drive A becomes Drive B, and Drive B becomes Drive A. By default, this field is set to **Disabled**.
- **Boot Up Floppy Seek**  
When enabled, the BIOS seeks for number of track (40 or 80) of the installed floppy drive. 360K type has 40 tracks while 760K, 1.2M and 1.44M have 80 tracks. By default, this field is set to **Enabled**.
- **Boot Up NumLock Status**  
This activates the NumLock function after powering up the system. By default, the system boots up with **NumLock ON**.
- **IDE HDD Block Mode**  
This field allows your hard disk controller to use the fast block mode to transfer data to and from your hard disk drive.
- **Gate A20 Option**  
This you to select how Gate A20 is worked. Gate A20 is a device used to address memory above 1 MB. The default setting is **Fast**.
- **Memory Parity Check/ECC Check**  
This option enables or disables parity error checking for system RAM. The settings are *Enabled* (all system RAM parity is checked) and *Disabled*.
- **Typematic Rate Setting**  
When disabled, continually holding down any key on your keyboard will generate only one instance. When enabled, you can set the two typematic controls listed next. By default, this field is set to **Disabled**.
- **Typematic Rate (Chars/Sec)**  
When the typematic rate is enabled, the system registers repeated keystrokes speeds. You can select speed range from 6 to 30 characters per second. By default, this item is set to **6**.
- **Typematic Delay (Msec)**  
When typematic rate is enabled, this item allows you to set the time interval between the display of the first and second characters. By default, this item is set to **250msec**.

- **Security Option**  
This allows you to limit access to the System and Setup. The default value is **Setup**. When set to *System*, the system prompts for the User Password every boot up. Selecting *Setup* always boots up and prompts for Supervisor Password only when Setup utility is called up.
- **PCI/VGA Palette Snoop**  
Some non-standard VGA display cards may not show colors properly. This field allows you to set whether MPEG ISA/VESA VGA Cards can work with PCI/VGA or not. When enabled, a PCI/VGA can work with a MPEG ISA/VESA VGA card. When disabled, a PCI/VGA cannot work with a MPEG ISA/VESA Card.
- **OS Select for DRAM > 64MB**  
This allows system to access more than 64MB of DRAM memory when used with OS/2 depends on certain BIOS calls to access memory. The default setting is **Non-OS/2**.
- **Video BIOS Shadow**  
This item allows you to change the Video BIOS location from ROM to RAM. Video Shadow will increase the video speed.
- **C8000 - CBFFF Shadow/DC000 - DFFFF Shadow**  
Shadowing ROM reduces available memory between 640KB and 1024KB. These fields determine whether optional ROM is copied to RAM or not.

### 7.4.1 Onboard VGA Functions

The following options allow the overriding of the VGA BIOS settings integrated in the core chipset of **SBC8161 Series**. Take note that the settings on the following will not take effect when a VGA peripheral card is connected to the system.

- **LCD Type**

Although the system chipset already supports VGA and LCD alike, BIOS Features Setup still expands this feature further with the option to set any of the 15 LCD types. The available options are:

■ Type 1/13	1024 x 768	DSTN
■ Type 2	1280 x 1024	TFT
■ Type 3	640 x 480	DSTN
■ Type 4	800 x 600	DSTN
■ Type 5	640 x 480 (16bit)	TFT
■ Type 6	640 x 480 (24bit)	TFT
■ Type 7	1024 x 768	TFT
■ Type 8/9/10	800 x 600	TFT
■ Type 11/12	800 x 600	DSTN
■ Type 14	1280 x 1024	DSTN
■ Type 15	1024 x 600	DSTN

- **VGA Expansion (Full Screen)**

This option allows you to enlarge application screens to full screen scale onto your display. However this option is not inversely compatible, rendering no change when applications screens have resolutions larger than the display resolution. The available options are Enabled and Disabled.

- **Display Type During/After POST**

This item configures the viewing area for the POST sequence. When configured to the *incorrect display setting* or *Both*, it blankets the POST sequence from being viewed. If you select *Default*, this option is useless and follows the VGA BIOS settings. The available options are CRT Only, LCD Only, Both, and Default.



## 7.5 Chipset Features Setup

This Setup menu controls the configuration of the motherboard chipset.

**ROM PCI/ISA BIOS  
CHIPSET FEATURES SETUP  
AWARD SOFTWARE, INC.**

Bank 0/1 DRAM Timing	: SDRAM 10ns	Current CPU Temp.	: 35°C/95°F
Bank 2/3 DRAM Timing	: SDRAM 10ns	Current System Temp.	: 35°C/95°F
Bank 4/5 DRAM Timing	: SDRAM 10ns	Current CPUFAN1 Speed	: 0RPM
SDRAM Cycle Length	: 3	Vcore: 1.97V	2.5V : 250V
DRAM Clock	: 66 MHz	3.3V : 3.33V	5V : 4.97V
Memory Hole	: Disabled	12V : 12.12V	
Read Around write	: Disabled		
Concurrent PCI/Host	: Disabled		
System BIOS Cacheable	: Disabled		
Video RAM Cacheable	: Disabled		
AGP Aperture Size	: 64		
Power Supply Type	: AT		
OnChip USB	: Enabled		
USB Keyboard Support	: Disabled		
		ESC : Quit	↑ ↓ → ← : Select Item
		F1 : Help	PU/PD/+/- : Modify
		F5 : Old Values	(Shift)F2 : Color
		F6 : Load BIOS Defaults	
		F7 : Load Setup Defaults	

- BANK0/1 DRAM Timing**  
This allows you to select the value of the board's paged DRAMs or EDO (extended data output) DRAMs. The available choices are EDO 50ns, EDO 60ns, Slow, Medium, Fast, and Turbo.
- SDRAM Cycle Length**  
When synchronous DRAM is installed, the number of clock cycles of CAS latency depends on the DRAM timing. Do not reset this field from the default value specified by the system designer. The available choices are 2 and 3.
- DRAM Clock**  
This item allows you to select the DRAM clock value, depending on whether the board has paged DRAMs or EDO (extended data output) DRAMs. The available choices are 66 MHz and Host CLK.

- **Memory Hole**  
To improve performance, certain space in memory is reserved for ISA cards. This memory must be mapped into the memory space below 16MB. The available choices are 15M-16M and Disabled.
- **Read Around write**  
DRAM optimization feature: If a memory read is addressed to a location whose latest write is being held in a buffer before being written to memory, the read is satisfied through the buffer contents, and the read is not sent to the DRAM. The available choices are Enabled and Disabled.
- **Concurrent PCI/Host**  
When disabled, CPU bus will be occupied during the entire PCI operation period. The available choices are Enabled and Disabled.
- **System BIOS Cacheable**  
When enabled, access to the system BIOS ROM addressed at F0000H-FFFFFH is cached, provided that the cache controller is disabled.
- **Video RAM Cacheable**  
Selecting *Enabled* allows caching of the video BIOS ROM at C0000h to C7FFFh, resulting in better video performance. However, if any program writes to this memory area, a memory access error may result.
- **AGP Aperture Size**  
The field sets aperture size of the graphics. The aperture is a portion of the PCI memory address range dedicated for graphics memory address space. Host cycles that hit the aperture range are forwarded to the AGP without any translation. The options available are 4M, 8M, 16M, 32M, 64M, 128M and 256M. The default setting is **64M**.
- **OnChip USB**  
This should be enabled if your system has a USB installed on the system board and you wish to use it. Even when so equipped, if you add a higher performance controller, you will need to disable this feature. The available choices are Enabled and Disabled.
- **USB Keyboard Support**  
Select *Enabled* if your system contains a Universal Serial Bus (USB) controller and you have a USB keyboard. The options available are Enabled, Disabled.

- **Current System/CPU Temp.**  
These read-only fields reflect the functions of the hardware thermal sensor that monitors the chip blocks and system temperatures to ensure the system is stable.
- **Current CPU Fan1 Speed**  
These optional and read-only fields show the current speeds in RPM (revolution per minute) for the CPU fan and chassis fan as monitored by the hardware monitoring IC.
- **Vcore/2.5V/3.3V/5V/12V**  
These optional and read-only fields show the current voltages in the voltage regulators and power supply as monitored by the hardware monitoring IC.

## 7.6 Power Management Setup

The Power Management Setup allows you to save energy of your system effectively. It will shut down the hard disk and turn OFF video display after a period of inactivity.

**ROM PCI/ISA BIOS  
POWER MANAGEMENT SETUP  
AWARD SOFTWARE, INC.**

ACPI Function	: Disabled	Primary INTR	: ON
Power Management	: User Define	IRQ3 (COM 2)	: Primary
PM Control by APM	: Yes	IRQ4 (COM 1)	: Primary
Video Off After	: Suspend	IRQ5 (LPT 2)	: Primary
Video Off Method	: V/H SYNC +Blank	IRQ6 (Floppy Disk)	: Primary
MODEM Use IRQ	: 3	IRQ7 (LPT 1)	: Primary
Doze Mode	: Instant-Off	IRQ8 (RTC Alarm)	: Disabled
Standby Mode	: Former-Sts	IRQ9 (IRQ Redir)	: Secondary
Suspend Mode	: Disable	IRQ10 (Reserved)	: Secondary
HDD Power Down	: Disable	IRQ11 (Reserved)	: Secondary
Throttle Duty Cycle	: Disable	IRQ12 (PS/2 Mouse)	: Primary
** PM Events **		IRQ13 (Coprocesor)	: Primary
VGA	: OFF	IRQ14 (Hard Disk)	: Primary
LPT & COM	: LPT/COM	IRQ15 (Reserved)	: Disabled
HDD & FDD	: ON		
DMA/master	: OFF	ESC : Quit	↑ ↓ → ← : Select Item
Modem Ring Resume	: Disabled	F1 : Help	PU/PD/+/- : Modify
RTC Alarm Resume	: Disabled	F5 : Old Values	(Shift)F2 : Color
		F6 : Load BIOS Defaults	
		F7 : Load Setup Defaults	

- **ACPI Function**  
This item allows you to enable/disable the Advanced Configuration and Power Management (ACPI). The options available are Enabled, Disabled.
- **Power Management**  
This category allows you to select the type (or degree) of power saving and is directly related to the following modes:
  - HDD Power Down
  - Doze Mode
  - Suspend ModeThere are four selections for Power Management, three of which have fixed mode settings.

Disable (default)	No power management. Disables all four modes
Min. Power Saving	Minimum power management. Doze Mode = 1 hr. Standby Mode = 1 hr., Suspend Mode = 1 hr., and HDD Power Down = 15 min.
Max. Power Saving	Maximum power management -- <b>ONLY AVAILABLE FOR SL CPU'S</b> . Doze Mode = 1 min., Standby Mode = 1 min., Suspend Mode = 1 min., and HDD Power Down = 1 min.
User Define	Allows you to set each mode individually. When not disabled, each of the ranges are from 1 min. to 1 hr. except for HDD Power Down which ranges from 1 min. to 15 min. and disable.

NOTE: *In order to enable the CPU overheat protection feature, the Power Management field should not be set to Disabled.*

- **PM Control by APM**  
When enabled, an Advanced Power Management device will be activated to enhance the Max. Power Saving mode and stop the CPU internal clock. If Advance Power Management (APM) is installed on your system, selecting Yes gives better power savings. If the Max. Power Saving is not enabled, this will be preset to No.
- **Video Off After**  
When enabled, this feature allows the VGA adapter to operate in a power saving mode.

Always On	Monitor will remain on during power saving modes.
Suspend --> Off	Monitor blanked when the system enters the Suspend mode.
Susp,Stby --> Off	Monitor blanked when the system enters either Suspend or Standby modes.
All Modes --> Off	Monitor blanked when the system enters any power saving mode.

- **Video Off Method**

This determines the manner in which the monitor is blanked.

V/H SYNC + Blank	This causes the system to turn off the vertical and horizontal synchronization ports and write blanks to the video buffer.
DPMS	Select this option if your monitor supports the Display Power Management Signaling (DPMS) standard of the Video Electronics Standards to select video power management values.
Blank Screen	This option only writes blanks to the video buffer.

- **Modem Use IRQ**

This field names the interrupt request (IRQ) line assigned to the modem (if any) on your system. Activity on the selected IRQ always awakens the system. The available choices are 3, 4, 5, 7, 9, 10, 11, and NA. By default, the IRQ is set to **3**.

### 7.6.1 PM Timers

The following four modes are Green PC power saving functions that are only user configurable when *User Defined Power Management* is selected. See above for available selections.

- **Doze Mode**

When enabled, and after the set time of system inactivity, the CPU clock runs at a slower speed while all other devices operate at full speed.

- **Standby Mode**

After the set period of system inactivity expires, the fixed disk drive and the video shut OFF while all other devices operate at full speed.

- **Suspend Mode**

When enabled, and after the set time of system inactivity, all devices except the CPU will be shut OFF.

- **HDD Power Down**  
When enabled, and after the set time of system inactivity, the hard disk drive is powered down while all other devices remain active.
- **Throttle Duty Cycle**  
When system enters Doze mode, the CPU clock runs only part of the time. You may select the percent of time that the clock runs.

### **7.6.2 PM Events**

PM events are I/O events whose occurrence can prevent the system from entering a power saving mode or can awaken the system from such a mode. In effect, the system remains alert for anything that occurs to a device that is configured as *On*, even when the system is in power down mode.

- **VGA**  
When enabled, any video activity restarts the global timer for Standby mode. The default setting is **Enabled**.
- **LPT & COM**  
When LPT & COM is *On*, any activity from one of the listed system peripheral devices or IRQs wakes up the system.
- **HDD & FDD**  
When *HDD & FDD* is *On*, any activity from one of the listed system peripheral devices wakes up the system.
- **DMA/master**  
When you *DMA / ISA Master* are *On*, any activity from one of the list system peripheral devices wakes up the system.
- **Modem Ring Resume**  
An input signal on the serial Ring Indicator (RI) line (in other words, an incoming call on the modem) awakens the system from a soft off state.
- **RTC Alarm Function**  
When *Enabled*, you can set the date and time at which the RTC (real-time clock) alarm awakens the system from Suspend mode.
- **Primary INTR**  
When set to *On*, any event occurring will awaken a system which has been powered down.  
The following is a list of IRQ's, Interrupt **Re**Quests, which can be exempted much as the COM ports and LPT ports above can. When an I/O device wants to gain the attention of the operating system,

it signals this by causing an IRQ to occur. When the operating system is ready to respond to the request, it interrupts itself and performs the service.

When set *On*, activity will neither prevent the system from going into a power management mode nor awaken it.

- IRQ3 (COM 2 )
- IRQ4 (COM 1)
- IRQ5 (LPT 2)
- IRQ6 (Floppy Disk)
- IRQ7 (LPT 1)
- IRQ8 (RTC Alarm)
- IRQ9 (IRQ2 Redir)
- IRQ10 (Reserved)
- IRQ11 (Reserved)
- IRQ12 ( PS / 2 Mouse )
- IRQ13 (Coprocessor)
- IRQ14
- IRQ15

## 7.7 PNP/PCI Configuration

This option configures the PCI bus system. All PCI bus systems on the system use INT#, thus all installed PCI cards must be set to this value.

**ROM PCI/ISA BIOS  
PNP/PCI CONFIGURATION  
AWARD SOFTWARE, INC.**

PNP OS Installed	: No	CPU to PCI Write Buffer	: Enabled
Resources Controlled by	: Auto	PCI Dynamic Bursting	: Enabled
Reset Configuration Data	: Disabled	PCI Master 0 WS Write	: Enabled
		PCI Delay Transaction	: Enabled
		PCI#2 Access #1 Retry	: Disabled
		AGP Master 1 WS Write	: Enabled
		AGP Master 1 WS Read	: Disabled
		PCI IRQ Activated By	: Edge
		Assign IRQ For USB	: Enabled
		Assign IRQ For VGA	: Enabled
		ESC : Quit	↑ ↓ → ← : Select Item
		F1 : Help	PU/PD/+/- : Modify
		F5 : Old Values	(Shift)F2 : Color
		F6 : Load BIOS Defaults	
		F7 : Load Setup Defaults	

- **PNP OS Installed**  
This item allows you to determine install PnP OS or not. The options available are Yes and No.
- **Resource controlled by**  
The Award Plug and Play BIOS has the capacity to automatically configure all of the boot and Plug and Play compatible devices. However, this capability means absolutely nothing unless you are using a Plug and Play operating system such as Windows®95. The options available are Auto and Manual.
- **Reset Configuration Data**  
Normally, you leave this field Disabled. Select Enabled to reset Extended System Configuration Data (ESCD) when you exit Setup or if you have installed a new add-on and the system reconfiguration has caused such a serious conflict that the operating system can not boot. The options available are Enabled and Disabled.
- **CPU to PCI Write Buffer**  
When *Enabled*, writes from the CPU to the PCI bus are buffered, to compensate for the speed differences between the CPU and the PCI bus. When *Disabled*, the writes are not buffered and the CPU must wait until the write is complete before starting another write cycle. The options available are Enabled and Disabled.
- **PCI Dynamic Bursting**  
When *Enabled*, every write transaction goes to the write buffer. Burstable transactions then burst on the PCI bus and non-burstable transactions don't. The options available are Enabled and Disabled.
- **PCI Master 0 WS Write**  
When *Enabled*, writes to the PCI bus are executed with zero wait states. The options available are Enabled and Disabled.
- **PCI Delay Transaction**  
The chipset has an embedded 32-bit posted write buffer to support delay transactions cycles. Select *Enabled* to support compliance with PCI specification version 2.1. The options available are Enabled, Disabled
- **PCI #2 Access #1 Retry**  
When PCI#2 (AGP bus) access to PCI#1 (PCI bus) has an error occurred. The options available are Enabled, Disabled



- **AGP Master 1 WS Write**  
When *Enabled*, writes to the AGP (Accelerated Graphics Port) are executed with one wait states. The options available are Enabled, Disabled
- **AGP Master 1 WS Read**  
When *Enabled*, read to the AGP (Accelerated Graphics Port) are executed with one wait states. The options available are Enabled, Disabled
- **PCI IRQ Activated by**  
This sets the method by which the PCI bus recognizes that an IRQ service is being requested by a device. Under all circumstances, you should retain the default configuration unless advised otherwise by your system's manufacturer. Choices are *Level* and *Edge*.
- **Assign IRQ For USB/VGA**  
Enable/Disable to assign IRQ for USB/VGA. The options available are Enabled, Disabled

## 7.8 Load BIOS Defaults

This option allows you to load the troubleshooting default values permanently stored in the BIOS ROM. These default settings are non-optimal and disable all high-performance features.

**ROM PCI/ISA BIOS  
CMOS SETUP UTILITY  
AWARD SOFTWARE, INC.**

STANDARD CMOS SETUP BIOS FEATURES SETUP CHIPSET FEATURES SETUP POWER MANAGEMENT SETUP PNP/PCI CONFIGURATION <b>LOAD BIOS DEFAULTS</b> LOAD SETUP DEFAULTS	INTEGRATED PERIPHERALS SUPERVISOR PASSWORD USER PASSWORD IDE HDD AUTO DETECTION SAVE & EXIT SETUP EXIT WITHOUT SAVING
ESC : Quit F10 : Save & Exit Setup	↑ ↓ → ← : Select Item (Shift)F2 : Change Color
Load BIOS Defaults except Standard CMOS Setup	

To load BIOS defaults value to CMOS SRAM, enter “Y”. If not, enter “N”.

## 7.9 Load Setup Defaults

This option allows you to load the default values to your system configuration. These default settings are optimal and enable all high performance features.

**ROM PCI/ISA BIOS  
CMOS SETUP UTILITY  
AWARD SOFTWARE, INC.**

STANDARD CMOS SETUP	INTEGRATED PERIPHERALS
BIOS FEATURES SETUP	SUPERVISOR PASSWORD
CHIPSET FEATURES SETUP	USER PASSWORD
POWER MANAGEMENT SETUP	IDE HDD AUTO DETECTION
PNP/PCI CONFIGURATION	SAVE & EXIT SETUP
LOAD BIOS DEFAULTS	EXIT WITHOUT SAVING
<b>LOAD SETUP DEFAULTS</b>	
ESC : Quit	↑ ↓ → ← : Select Item
F10 : Save & Exit Setup	(Shift)F2 : Change Color
Load BIOS Defaults except Standard CMOS Setup	

To load SETUP defaults value to CMOS SRAM, enter “Y”. If not, enter “N”.

## 7.10 Integrated Peripherals

This option sets your hard disk configuration, mode and port.

**ROM PCI/ISA BIOS  
INTEGRATED PERIPHERALS  
AWARD SOFTWARE, INC.**

OnChip IDE Channel0 : Enabled	Onboard Parallel Mode : Normal
IDE Prefetch Mode : Disabled	Onboard Parallel Port : 378/IRQ7
Primary Master PIO: Auto	
Primary Slave PIO: Auto	
Secondary Master PIO: Auto	
Secondary Slave PIO: Auto	
Primary Master UDMA: Auto	
Primary Slave UDMA: Auto	Onboard PCI SCSI Chip : Enabled
Secondary Master UDMA: Auto	
Secondary Slave UDMA: Auto	
Init Display First : PCI Slot	
Onboard FDD Controller : Enabled	
Onboard Serial Port 1 : 3F8/IRQ4	
Onboard Serial Port 2 : 2F8/IRQ3	
UART 2 Mode : Standard	
	ESC : Quit           ↑ ↓ → ← : Select Item
	F1 : Help            PU/PD/+/- : Modify
	F5 : Old Values     (Shift)F2 : Color
	F6 : Load BIOS Defaults
	F7 : Load Setup Defaults

- OnChip IDE Channel 0**  
The chipset contains a PCI IDE interface with support for two IDE channels. Select *Enabled* to activate the primary IDE interface. Select *Disabled* to deactivate this interface.
- IDE Prefetch Mode**  
The onboard IDE drive interfaces support IDE prefetching, for faster drive accesses. If you install a primary and/or secondary add-in IDE interface, set this to *Disabled* if the interface does not support prefetching. The options available are Enabled, Disabled.

- **Primary/Secondary Master/Slave PIO**  
The four IDE PIO (Programmed Input/Output) fields let you set a PIO mode (0-4) for each of the four IDE devices that the onboard IDE interface supports. Modes 0 through 4 provide successively increased performance. In Auto mode, the system automatically determines the best mode for each device. The options available are Auto, Mode 0, Mode 1, Mode 2, Mode 3, and Mode 4.
- **Primary/Secondary Master/Slave UDMA**  
Ultra DMA/66 implementation is possible only if your IDE hard drive supports it and the operating environment includes a DMA driver (Windows 95 OSR2 or a third-party IDE bus master driver). If your hard drive and your system software both support Ultra DMA 33/66, select Auto to enable BIOS support. The options available are Auto, Mode 0, Mode 1, and Mode 2.
- **Init Display First**  
This item allows you to decide to active whether PCI Slot or AGP first. The options available are PCI Slot, AGP.
- **Onboard FDD Controller**  
Select Enabled if your system has a floppy disk controller (FDC) installed on the system board and you wish to use it. If you install and-in FDC or the system has no floppy drive, select Disabled in this field. The options available are Enabled, Disabled.
- **Onboard Serial Port 1/Port 2**  
Select an address and corresponding interrupt for the first and second serial ports. The options available are 3F8/IRQ4, 2E8/IRQ3, 3E8/IRQ4, 2F8/IRQ3, Disabled, Auto.
- **UART 2 Mode**  
This item allows you to determine which Infra Red (IR) function of onboard I/O chip. The options available are IrDA 1.0, Standard, ASKIR, and HPSIR.
- **Onboard Parallel Mode**  
Select an operating mode for the onboard parallel (printer) port. Select Normal unless your hardware and software require one of the other modes offered in this field. The options available are EPP1.9, ECP, SPP, ECPEPP1.7, EPP1.7.
- **Onboard Parallel Port**  
This item allows you to determine access onboard parallel port controller with which I/O address. The options available are 378H/IRQ7, 278H/IRQ5, 3BC/IRQ7, Disabled.

- **Onboard PCI SCSI Chip**  
This item allows you to enable or disable the onboard Adaptec AIC-7890 SCSI chip of **SBC8161 Series**. The options available are Enabled and Disabled.

## 7.11 Supervisor / User Password

These two options set the system password. Supervisor Password sets a password that will be used to protect the system and Setup utility. User Password sets a password that will be used exclusively on the system. To specify a password, highlight the type you want and press <Enter>. The Enter Password: message prompts on the screen. Type the password, up to eight characters in length, and press <Enter>. The system confirms your password by asking you to type it again. After setting a password, the screen automatically returns to the main screen.

To disable a password, just press the <Enter> key when you are prompted to enter the password. A message will confirm the password to be disabled. Once the password is disabled, the system will boot and you can enter Setup freely.

**ROM PCI/ISA BIOS  
CMOS SETUP UTILITY  
AWARD SOFTWARE, INC.**

STANDARD CMOS SETUP	INTEGRATED PERIPHERALS
BIOS FEATURES SETUP	<b>SUPERVISOR PASSWORD</b>
CHIPSET FEATURES SETUP	USER PASSWORD
POWER MANAGEMENT SETUP	IDE HDD AUTO DETECTION
PNP/PCI CONFIGURATION	HDD LOW LEVEL FORMAT
LOAD BIOS DEFAULTS	SAVE & EXIT SETUP
LOAD SETUP DEFAULTS	EXIT WITHOUT SAVING
ESC : Quit	↑ ↓ → ← : Select Item
F10 : Save & Exit Setup	(Shift) F2 : Change Color
Change / Set / Disable Password	

## 7.12 IDE HDD Auto Detection

This option detects the parameters of an IDE hard disk drive, and automatically enters them into the Standard CMOS Setup screen.

ROM PCI/ISA BIOS  
STANDARD CMOS SETUP  
AWARD SOFTWARE, INC.

HARD DISKS	TYPE	SIZE	CYLS	HEAD	PRECOMP	LANDZ	SECTOR	MODE
Primary								
Master:								
Select Primary Master Option (N=SKIP) : N								
OPTI	TYPE	SIZE	CYLS	HEAD	PRECOMP	LANDZ	SECTOR	MODE
ONS								
1 (Y)	0	0	0	0	0	0	0	NORMAL

**NOTE: Some OSes (like SCO-UNIX) must use "NORMAL" for installation**

Up to four IDE drives can be detected, with parameters for each appearing in sequence inside a box. To accept the displayed entries, press the "Y" key; to skip to the next drive, press the "N" key. If you accept the values, the parameters will appear listed beside the drive letter on the screen.

## 7.13 Save & Exit Setup

This allows you to determine whether or not to accept the modifications. Typing “Y” quits the setup utility and saves all changes into the CMOS memory. Typing “N” brings you back to Setup utility.

**ROM PCI/ISA BIOS  
CMOS SETUP UTILITY  
AWARD SOFTWARE, INC.**

STANDARD CMOS SETUP	INTEGRATED PERIPHERALS
BIOS FEATURES SETUP	SUPERVISOR PASSWORD
CHIPSET FEATURES SETUP	USER PASSWORD
POWER MANAGEMENT SETUP	IDE HDD AUTO DETECTION
PNP/PCI CONFIGURATION	<b>SAVE &amp; EXIT SETUP</b>
LOAD BIOS DEFAULTS	EXIT WITHOUT SAVING
LOAD SETUP DEFAULTS	
ESC : Quit	↑ ↓ → ← : Select Item
F10 : Save & Exit Setup	(Shift) F2 : Change Color
Save Data to CMOS & Exit Setup	

## 7.14 Exit Without Saving

Select this option to exit the Setup utility without saving the changes you have made in this session. Typing “Y” will quit the Setup utility without saving the modifications. Typing “N” will return you to Setup utility.

**ROM PCI/ISA BIOS  
CMOS SETUP UTILITY  
AWARD SOFTWARE, INC.**

STANDARD CMOS SETUP	INTEGRATED PERIPHERALS
BIOS FEATURES SETUP	SUPERVISOR PASSWORD
CHIPSET FEATURES SETUP	USER PASSWORD
POWER MANAGEMENT SETUP	IDE HDD AUTO DETECTION
PNP/PCI CONFIGURATION	SAVE & EXIT SETUP
LOAD BIOS DEFAULTS	EXIT WITHOUT SAVING
LOAD SETUP DEFAULTS	
ESC : Quit	↑ ↓ → ← : Select Item
F10 : Save & Exit Setup	(Shift) F2 : Change Color
Abandon all Data & Exit Setup	



## Appendix A

### Watchdog Timer

#### Using the Watchdog Function

The **SBC8161 Series** CPU card uses version 2.0 of the watchdog timer. This onboard WDT generates either a system reset or non-maskable interrupt (NMI), depending on the settings made on jumper **JP12** of **SBC8161 Series**. Follow the steps below to enable and program the watchdog function of **SBC8161 Series**.

Start

↓

Un-Lock WDT : OUT 120H 0AH ; enter WDT function  
OUT 120H 0BH ; enable WDT function

↓

Set multiple (1~4) : OUT 120 0NH ; N=1,2,3 or 4

↓

Set base timer (0~F) : OUT 121 0MH ; M=0,1,2,...F

↓

WDT counting

↓

re-set timer : OUT 121 0MH ; M=0,1,2,...F

↓

IF No re-set timer : WDT time-out, generate RESET or NMI

↓

IF to disable WDT : OUT 120 00H ; Can be disable at any time

M	N			
	1	2	3	4
0	0.5 sec.	5 secs.	50 secs.	100 secs.
1	1 sec.	10 secs.	100 secs.	200 secs.
2	1.5 secs.	15 secs.	150 secs.	300 secs.
3	2 secs.	20 secs.	200 secs.	400 secs.
4	2.5 secs.	25 secs.	250 secs.	500 secs.
5	3 secs.	30 secs.	300 secs.	600 secs.
6	3.5 secs.	35 secs.	350 secs.	700 secs.
7	4 secs.	40 secs.	400 secs.	800 secs.
8	4.5 secs.	45 secs.	450 secs.	900 secs.
9	5 secs.	50 secs.	500 secs.	1000 secs.
A	5.5 secs.	55 secs.	550 secs.	1100 secs.
B	6 secs.	60 secs.	600 secs.	1200 secs.
C	6.5 secs.	65 secs.	650 secs.	1300 secs.
D	7 secs.	70 secs.	700 secs.	1400 secs.
E	7.5 secs.	75 secs.	750 secs.	1500 secs.
F	8 secs.	80 secs.	800 secs.	1600 secs.

## Appendix B

### Connector Pin Assignments

#### 40-pin IDE Interface Connector: CN6

Pin	Description	Pin	Description	Pin	Description
1	Reset #	2	GND	3	Data 7
4	Data 8	5	Data 6	6	Data 9
7	Data 5	8	Data 10	9	Data 4
10	Data 11	11	Data 3	12	Data 12
13	Data 2	14	Data 13	15	Data 1
16	Data 14	17	Data 0	18	Data 16
19	GND	20	N/C	21	N/C
22	GND	23	IOW #	24	GND
25	IOR #	26	GND	27	IOCHRDY
28	N/C	29	N/C	30	GND-Default
31	Interrupt	32	N/C	33	SA1
34	N/C	35	SA0	36	SA2
37	HDC CS0 #	38	HDC CSI #	39	HDD Active #
40	GND				

#### Floppy Disk Connector: CN2

Pin	Description	Pin	Description	Pin	Description
1	GND	2	Reduce write current	3	GND
4	N/C	5	GND	6	N/C
7	GND	8	Index#	9	GND
10	Motor enable A#	11	GND	12	Drive select B#
13	GND	14	Drive select A#	15	GND
16	Motor enable B#	17	GND	18	Direction#
19	GND	20	STEP#	21	GND
22	Write data#	23	GND	24	Write gate#
25	GND	26	Track 0 #	27	GND
28	Write protect#	29	GND	30	Read data#
31	GND	32	Side 1 select#	33	GND
34	Disk change#				

**Parallel Port Connector: CN3**

Pin	Description	Pin	Description
1	Strobe#	14	Auto Form Feed#
2	Data 0	15	Error#
3	Data 1	16	Initialize#
4	Data 2	17	Printer Select In#
5	Data 3	18	GND
6	Data 4	19	GND
7	Data 5	20	GND
8	Data 6	21	GND
9	Data 7	22	GND
10	Acknowledge#	23	GND
11	Busy	24	GND
12	Paper Empty#	25	GND
13	Printer Select	26	

**Serial Ports Pin Assignment**

CN16 Pin	CN12/ 13 Pin	Description
1	1	Data Carrier Detect (DCD)/5V/12V
6	2	Data Set Ready (DSR)
2	3	Receive Data (RXD)
7	4	Request to Send (RTS)
3	5	Transmit Data (TXD)
8	6	Clear to Send (CTS)
4	7	Data Terminal Ready (DTR)
9	8	Ring Indicator (RI)/5V/12V
5	9	Ground (GND)
X	10	GND

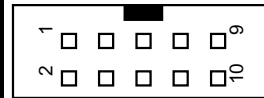

CN12 / CN13

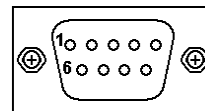

CN16

USB Connector: CN10

Pin	Description	Pin	Description
1	USB Vcc	2	USB Vcc
3	USB P0-	4	USB P1-
5	USB P0+	6	USB P1+
7	GND	8	GND
9	NC	10	NC

Case Fan Connector: CN23

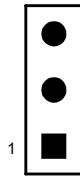

Pin	Description
1	Speed Sensor
2	+12V
3	GND

CPU Fan Connector: CN24



Pin	Description
1	Speed Sensor
2	+12V
3	GND

## SCSI Connectors

### CN9 : Ultra Wide SCSI Connector

Pin	Description	Pin	Description
1	GND	35	CHA_SCD12
2	GND	36	CHA_SCD13
3	GND	37	CHA_SCD14
4	GND	38	CHA_SCD15
5	GND	39	CHA_SCDPH
6	GND	40	CHA_SCD0
7	GND	41	CHA_SCD1
8	GND	42	CHA_SCD2
9	GND	43	CHA_SCD3
10	GND	44	CHA_SCD4
11	GND	45	CHA_SCD5
12	GND	46	CHA_SCD6
13	GND	47	CHA_SCD7
14	GND	48	CHA_SCDPL
15	GND	49	GND
16	GND	50	GND
17	N/C	51	RTPWR
18	N/C	52	RTPWR
19	N/C	53	N/C
20	N/C	54	GND
21	GND	55	CHA_ATN
22	GND	56	GND
23	GND	57	CHA_BSY
24	GND	58	CHA_ACK
25	GND	59	CHA_RST
26	GND	60	CHA_MSG
27	GND	61	CHA_SEL
28	GND	62	CHA_CD
29	GND	63	CHA_REQ
30	GND	64	CHA_IO
31	GND	65	CHA_SCD8
32	GND	66	CHA_SCD9
33	GND	67	CHA_SCD10
34	GND	68	CHA_SCD11

• CN10 : Ultra2 Wide SCSI Connector

Pin	Description	Pin	Description
1	CHA_SCDP12	35	CHA_SCDM12
2	CHA_SCDP13	36	CHA_SCDM13
3	CHA_SCDP14	37	CHA_SCDM14
4	CHA_SCDP15	38	CHA_SCDM15
5	CHA_SCDPHP	39	CHA_SCDPHM
6	CHA_SCDP0	40	CHA_SCDM0
7	CHA_SCDP1	41	CHA_SCDM1
8	CHA_SCDP2	42	CHA_SCDM2
9	CHA_SCDP3	43	CHA_SCDM3
10	CHA_SCDP4	44	CHA_SCDM4
11	CHA_SCDP5	45	CHA_SCDM5
12	CHA_SCDP6	46	CHA_SCDM6
13	CHA_SCDP7	47	CHA_SCDM7
14	CHA_SCDPLP	48	CHA_SCDPLM
15	GND	49	GND
16	CHA_DIFFSENSE	50	N/C
17	TRMPWRS	51	TRMPWRS
18	TRMPWRS	52	TRMPWRS
19	N/C	53	N/C
20	GND	54	GND
21	CHA_ATNP	55	CHA_ATNM
22	GND	56	GND
23	CHA_BSYP	57	CHA_BSYM
24	CHA_ACKP	58	CHA_ACKM
25	CHA_RSTP	59	CHA_RSTM
26	CHA_MSGP	60	CHA_MSGM
27	CHA_SELP	61	CHA_SELM
28	CHA_CDP	62	CHA_CDM
29	CHA_REQP	63	CHA_REQM
30	CHA_IOP	64	CHA_IOM
31	CHA_SCD8P	65	CHA_SCDM8
32	CHA_SCD9P	66	CHA_SCDM9
33	CHA_SCD10P	67	CHA_SCDM10
34	CHA_SCD11P	68	CHA_SCDM11

**CN8 : Narrow SCSI Connector**

Pin	Description	Pin	Description
1	GND	2	CHA_SCD0
3	GND	4	CHA_SCD1
5	GND	6	CHA_SCD2
7	GND	8	CHA_SCD3
9	GND	10	CHA_SCD4
11	GND	12	CHA_SCD5
13	GND	14	CHA_SCD6
15	GND	16	CHA_SCD7
17	GND	18	CHA_SCDPL
19	GND	20	GND
21	GND	22	GND
23	GND	24	N/C
25	GND	26	RTPWR
27	GND	28	N/C
29	GND	30	GND
31	GND	32	CHA_ATN
33	GND	34	GND
35	GND	36	CHA_BSY
37	GND	38	CHA_ACK
39	GND	40	CHA_RST
41	GND	42	CHA_MSG
43	GND	44	CHA_SEL
45	GND	46	CHA_CD
47	GND	48	CHA_REQ
49	GND	50	CHA_IO

**WAKE ON LAN Connector: CN4**

Pin	Description
1	5VSB
2	GND
3	WOL



## Appendix C

### Ultra DMA/66 Reference

#### Overview

Ultra ATA/66 is a low cost extension of the Ultra ATA/33 hard drive interface that doubles its burst data rate. Also known as Ultra DMA/66 and Fast ATA-2, Ultra ATA/66 allows host computers to send and receive data at 66.6 MB/s, which is twice the data transfer speeds of 33.3 MB/s of Ultra DMA/33. The result is maximum disk performance under PCI local bus environments.

At its fast burst data rates, Ultra ATA/66 will go farther than Ultra ATA/33 in removing bottlenecks associated with data transfers, especially during sequential operations. Ultra ATA/66 also delivers heightened data integrity to the EIDE interface through use of a 40-pin 80-conductor cable, and CRC (Cyclic Redundancy Check) error detection code. The 80-conductor cable reduces crosstalk and improves signal integrity by providing 40 additional ground lines between the 40-pin IDE signal and ground lines. The connector is plug-compatible with existing 40-pin headers, and the incremental cost for the cable should be minimal. As with Ultra ATA/33, CRC ensures the integrity of transferred data.

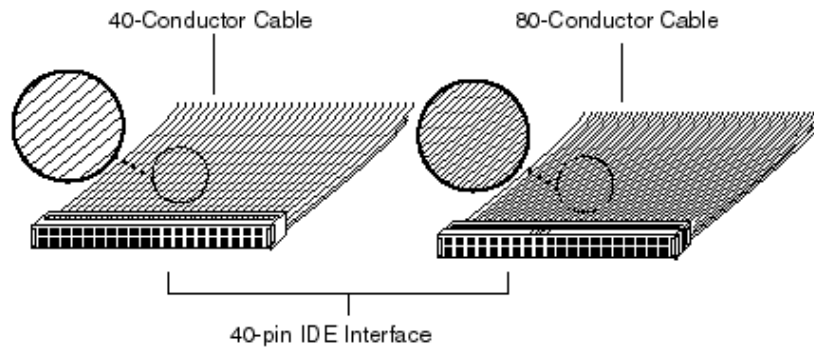

## **Background**

Ultra ATA/66 is the latest ATA/IDE hard drive data transfer protocol for moving data between the hard drive buffer and the system memory. The previous interface was Ultra ATA/33, with a maximum burst transfer rate of 33.3 MB/s. Prior to Ultra ATA/33 was multi-word DMA Mode 2 with a maximum burst transfer rate of 16.6 MB/s. Ultra ATA/66 doubles Ultra ATA/33's maximum burst rate and quadruples multi-word DMA's maximum burst rate to 66.6 MB/s.

By increasing the burst transfer rates of IDE drives, Ultra ATA/66 brings the effective transfer rate of the system's bus and a drive's internal data rate that much closer into balance. Ultra ATA/66 allows system designers to provide greater system throughput, particularly for long sequential transfers required by audio/visual applications.

Host data transfer rates must exceed media data transfer rates or else performance is reduced because of additional revolutions due to buffer full/empty conditions on reads/writes.

## **Host Data Rate Requirements**

As you can see by the chart, the host data transfer rate doubles about every three years. The chart indicates that Ultra ATA/66 will reach its limits by 2002. The industry has supported host transfer data rates doubling previously with:

- DMA Mode 2 at 16.6 MB/s in 1994
- Ultra ATA/33 at 33.3 MB/s in 1997
- Ultra ATA/66 at 66.6 MB/s in 1999

With continued expansions in disk capacity and higher rotational speeds, the hard drive's internal disk rates also continue to increase. The transfer of large files, often written sequentially on the hard drive, is particularly affected by the transfer rate. During sequential reads, the hard drive, because of its fast internal data rate, may fill its buffer faster than the host can empty it when using the Ultra ATA/33 or the older multi-word DMA interfaces. Performance bottlenecks usually result in this

connection between the host and the hard drive. Improving the interface to keep up with internal data rate improvements is exactly what Ultra ATA/66 can achieve.

As previously mentioned, fast host data transfer rates help maintain sequential media transfers, but they also accelerate cache hits. The following table is based on all commands are either a cache hit (data comes from the buffer and has <1 ms latency), or a cache miss (data comes from the media and has >10 ms latency.)

Ultra ATA/66 Performance Benefit		
	Cache Miss	Cache Hit
Sequential	Yes	Yes
Random	No	Yes

## **Backward Compatibility**

The Ultra ATA/66 protocol and commands are designed to be compatible with existing ATA devices and systems. Drives implementing Ultra ATA/66 are fully backward compatible with older ATA modes, including Ultra ATA/33. It will handle all the data transfer modes. The slower modes will be supported with a different clock signal and clock divider. The slower modes previously worked with a standard 40-pin interface cable, but Ultra ATA/66 requires a 40-pin 80-conductor cable for modes 3 and 4.

	Data Transfer Rate (max.)	Cable	Conductors	CRC
DMA Mode1	11.1 MB/s	40-pin IDE	40-pin	No
Multi-word DMA Mode 1	13.3 MB/s	40-pin IDE	40-pin	No
Multi-word DMA Mode 2	16.6 MB/s	40-pin IDE	40-pin	No
Ultra ATA Mode 2	33.3 MB/s	40-pin IDE	40-pin	Yes
Ultra ATA Mode 4	66.6 MB/s	40-pin IDE	80-pin	Yes

Hard drives that support Ultra ATA/66 also support Ultra ATA/33 and multi-word DMA, and can be used with existing multi-word DMA host chipsets. Installed PCs without Ultra ATA/66 capability can use new hard drives in legacy ATA modes at transfer rates up to 33.3 MB/s. However, by upgrading with an Ultra ATA/66 PCI adapter card and 80-conductor cable, they can also take advantage of the interface's newer speed and data integrity features. Bus timings must be scaled to transfer up to twice as fast.

PC vendors who would like to incorporate the advantages of Ultra ATA/66 in new systems can do so by using new chipsets and motherboards from Intel and other leading vendors that license the technology. Although a new cable is required for Ultra ATA/66, the chipset pin count remains the same at 40.

## **System Requirements for Ultra ATA/66**

To use the Ultra ATA/66 technology, a system must have:

- Ultra ATA/66 compatible logic either on the system motherboard, or on an Ultra DMA PCI adapter card
- Ultra DMA compatible BIOS
- DMA-aware device driver for the operating system
- Ultra ATA/66-compatible IDE device such as a hard drive or CD-ROM drive
- 40-pin 80-conductor cable

## **Frequently Asked Questions**

1. *Can I run UDMA/66 on a 40 pin 40 conductor cable?*  
No, the UDMA/66 technology is defined such that the PC and the HDD can both detect the presence of the 80-conductor cable. UDMA/66 will not be enabled unless the 80-conductor cable is present.
2. *I have an UDMA/33 system today. How can I support UDMA/66?*  
An existing system can be upgraded by purchasing a PCI-EIDE controller that supports UDMA/66.
3. *Do Microsoft Operating Systems support UDMA?*  
Windows releases indicate that they all support DMA transfers. Windows does not know the difference between Ultra ATA/33 or Ultra ATA/66. UDMA data transfer rate is determined by your HDD, your controller and the BIOS. This applies for all the following Windows operating systems:
  - Windows 2000
  - Windows 98
  - Windows NT Service Pack 3
  - Windows 95 OEM Service Release 2
4. *I don't have a system that supports Ultra ATA/66, can I run the Ultra ATA/66 HDD in it?*  
Yes, the HDD will not run in UDMA/66 mode but instead is a slower compatible mode such as Ultra ATA/33, DMA Mode 2 (16.6 MB/s) or PIO Mode 4 (16.6MB/s)
5. *Can I mix Ultra ATA/33 and Ultra ATA/66 drives on the same cable?*  
Yes, a legacy ATA (IDE) specification drive can coexist with an Ultra ATA/66 drive. However, for the Ultra ATA/66 device to attain Ultra DMA 4 mode, an Ultra ATA/66 capable cable is required.

**6. What are some common troubleshooting steps?**

- Make sure the cable is Ultra ATA/66 capable. An Ultra ATA/66-capable cable is a 40-pin, 80-conductor cable with a black connector on one end, a blue connector on the other end and a gray connector in the middle. In addition, line 34 on the cable should be notched or cut (this may be difficult to see with the human eye).
- Make sure the system board is capable of Ultra ATA/66. An Ultra ATA/66 capable system board has a detect circuit with a capacitor for detecting line 34 missing on the cable. If there is no capacitor, the system can wrongly detect the presence of an Ultra ATA/66 cable and therefore try to configure the device for a higher transfer rate.
- Some system boards may not successfully handle Ultra ATA/66 on both ATA (IDE) channels. If you have difficulty, consider troubleshooting with the device in the Primary Master position.
- Contact the system board manufacturer for the latest BIOS upgrade and any Ultra ATA/66 special device drivers or patches.
- Make sure the operating system is DMA capable and that the DMA mode is activated. (For Windows 95/98, check Device Manager | Drive Settings tab for a check box.)
- Make sure the drive is Ultra ATA/66 capable and has been configured to run at Ultra ATA/66 transfer rates. (Seagate drives require an Ultra ATA/66 activation utility.)